

CE/EMC TEST REPORT

For

NANTONG KUNLONG ELECTRICAL AND MECHANICAL TOOLS CO., LTD

Product Name:	Electric drill
Brand Name:	N/A
Model Number:	KL1005
Prepared For:	NANTONG KUNLONG ELECTRICAL AND MECHANICAL TOOLS CO., LTD
Address:	88Huanghai Highway, Wang Baozhen, Kaidong City, Nantong City, Jiangsu Province, China
Prepared By:	Shenzhen SiCT Technology Co., Ltd.
Address:	202, Building 3, No.111 Huanguan Middle Road, Songyuanxia Community, Guanhu Street, Longhua District, Shenzhen, Guangdong, China
Report No.:	XK2209012188E

TABLE OF CONTENT

	Page
Test Report Declaration	
1. GENERAL INFORMATION	5
1.1. Description of Device (EUT)	5
1.2. Tested System Details	5
1.3. Test Uncertainty	5
2. TEST INSTRUMENT USED	6
3. CONDUCTED EMISSION AT THE MAINS TERMINALS TEST	9
3.1. Block Diagram Of Test Setup	9
3.2. Test Standard	9
3.3. Power Line Conducted Emission Limit	9
3.4. EUT Configuration on Test	9
3.5. Operating Condition of EUT	10
3.6. Test Procedure	10
3.7. Test Result	10
4. RADIATION EMISSION TEST	13
4.1. Block Diagram of Test Setup	13
4.2. Test Standard	13
4.3. Radiation Limit	13
4.4. EUT Configuration on Test	14
4.5. Operating Condition of EUT	14
4.6. Test Procedure	14
4.7. Test Result	14
5. HARMONIC CURRENT EMISSION TEST	17
5.1. Block Diagram of Test Setup	17
5.2. Test Standard	17
5.3. Operating Condition of EUT	17
5.4. Test Procedure	17
5.5. Test Results	17
6. VOLTAGE FLUCTUATIONS & FLICKER TEST	18
6.1. Block Diagram of Test Setup	18
6.2. Test Standard	18
6.3. Operating Condition of EUT	18
6.4. Test Procedure	18
6.5. Test Results	18
7. IMMUNITY TEST OF GENERAL THE PERFORMANCE CRITERIA	19
8. ELECTROSTATIC DISCHARGE IMMUNITY TEST	20
8.1. Block Diagram of Test Setup	20
8.2. Test Standard	20
8.3. Severity Levels and Performance Criterion	20
8.4. Test Procedure	21
8.5. Test Results	21
9. RF FIELD STRENGTH SUSCEPTIBILITY TEST	22
9.1. Block Diagram of Test Setup	22
9.2. Test Standard	22
9.3. Severity Levels and Performance Criterion	22
9.4. Test Procedure	23
9.5. Test Results	23
10. ELECTRICAL FAST TRANSIENT/BURST IMMUNITY TEST	24
10.1. Block Diagram of EUT Test Setup	24
10.2. Test Standard	24

10.3.	Severity Levels and Performance Criterion.....	24
10.4.	Test Procedure	25
10.5.	Test Results	25
11.	SURGE TEST	26
11.1.	Block Diagram of EUT Test Setup	26
11.2.	Test Standard.....	26
11.3.	Severity Levels and Performance Criterion.....	26
11.4.	Test Procedure	26
11.5.	Test Result	27
12.	INJECTED CURRENTS SUSCEPTIBILITY TEST	28
12.1.	Block Diagram of EUT Test Setup	28
12.2.	Test Standard.....	28
12.3.	Severity Levels and Performance Criterion.....	28
12.4.	Test Procedure	29
12.5.	Test Result	29
13.	VOLTAGE DIPS AND INTERRUPTIONS TEST	30
13.1.	Block Diagram of EUT Test Setup	30
13.2.	Test Standard.....	30
13.3.	Severity Levels and Performance Criterion.....	30
13.4.	Test Procedure	30
13.5.	Test Result	31
14.	EUT PHOTOGRAPHS	32

TEST RESULT CERTIFICATION

Applicant : NANTONG KUNLONG ELECTRICAL AND MECHANICAL TOOLS CO., LTD

Address : 88Huanghai Highway, Wang Baozhen, Kaidong City, Nantong City, Jiangsu Province, China

Manufacturer : NANTONG KUNLONG ELECTRICAL AND MECHANICAL TOOLS CO., LTD

Address : 88Huanghai Highway, Wang Baozhen, Kaidong City, Nantong City, Jiangsu Province, China

EUT : Electric drill

Brand Name: : N/A

Model Number : KL1005

Date of Receipt: : September 26, 2022

Test Date : September 26-30, 2022

Date of Report : September 30, 2022

Test Result: : The equipment under test was found to be compliance with the requirements of the standards applied.

Test Procedure Used:

EMI : EN IEC 55014-1:2021
EN IEC 61000-3-2:2019+A1:2021
EN 61000-3-3:2013+A2:2021

EMS : EN IEC 55014-2:2021

Prepared by:



Project Engineer

Reviewed by:



Project Supervisor

Approved by:



Technical Director



This test report is based on a single evaluation of one sample of above mentioned products. It is not permitted to be duplicated in extracts without written approval of Shenzhen SiCT Technology Co., Ltd.

1. GENERAL INFORMATION

1.1. Description of Device (EUT)

EUT : Electric drill
Brand Name : N/A
Model Number : KL1005
Model Difference : N/A
Power Supply : Adapter: Input AC100-240V 50/60Hz
Output DC21V 1A
Electric drill:DC 21V 1A

Note: KL1005 was selected as the test model and the data's have been recorded in this report.

1.2. Tested System Details

None.

1.3. Test Uncertainty

Conducted Emission
Uncertainty : $\pm 2.66\text{dB}$

Radiated Emission Uncertainty : $\pm 4.26\text{dB}$

2. TEST INSTRUMENT USED

For Conducted Emission at the mains terminals Test

Conducted Emission Test (A --- site)					
Equipment	Manufacturer	Model#	Serial#	Last Cal.	Next Cal.
843 Shielded Room	ChengYu	843 Room	843	Apr. 2,2022	Apr. 1,2023
EMI Receiver	R&S	ESCI	101421	Apr. 2,2022	Apr. 1,2023
LISN	SCHWARZB ECK	NSLK8127	812779	Apr. 2,2022	Apr. 1,2023

For Disturbance Power Test

Conducted Emission Test (A --- site)					
Equipment	Manufacturer	Model#	Serial#	Last Cal.	Next Cal.
EMI Receiver	R&S	ESCI	101421	Apr. 2,2022	Apr. 1,2023
Power Clamp	LUTHI	MDS21	4293	Apr. 2,2022	Apr. 1,2023
Attenuator	R&S	ESH3-Z2	DL021E	Apr. 2,2022	Apr. 1,2023
843 Cable 2#	FUJIKURA	843C1#	002	Apr. 2,2022	Apr. 1,2023

For Radiated Emission Test

Radiation Emission Test (966 chamber)					
Equipment	Manufacturer	Model#	Serial#	Last Cal.	Next Cal.
966 chamber	ChengYu	966 Room	966	Apr. 2,2022	Apr. 1,2023
Spectrum Analyzer	Agilent	E4407B	MY45109572	Apr. 2,2022	Apr. 1,2023
Amplifier	Schwarzbeck	BBV9743	9743-119	Apr. 2,2022	Apr. 1,2023
Amplifier	Schwarzbeck	BBV9718	9718-270	Apr. 2,2022	Apr. 1,2023
Log-periodic Antenna	Schwarzbeck	VULB9160	VULB9160-3 369	Apr. 2,2022	Apr. 1,2023
EMI Receiver	R&S	ESCI	101421	Apr. 2,2022	Apr. 1,2023
Horn Antenna	Schwarzbeck	BBHA9120D	9120D-1275	Apr. 2,2022	Apr. 1,2023
966 Cable 1#	CHENGYU	966	004	Apr. 2,2022	Apr. 1,2023
966 Cable 2#	CHENGYU	966	003	Apr. 2,2022	Apr. 1,2023

For Harmonic & Flicker Test

For Harmonic / Flicker Test (A --- site)					
Equipment	Manufacturer	Model#	Serial#	Last Cal.	Next Cal.
Harmonic / Flicker Analyzer	KIKUSUI	KHA1000	VA002445	Apr. 2,2022	Apr. 1,2023
AC Power Supply	KIKUSUI	PCR4000M	UK001879	Apr. 2,2022	Apr. 1,2023
Line Impedance network	KIKUSUI	LIN1020JF	UL001611	Apr. 2,2022	Apr. 1,2023

For Electrostatic Discharge Immunity Test

For Electrostatic Discharge Immunity Test (A --- site)					
Equipment	Manufacturer	Model#	Serial#	Last Cal.	Next Cal.
ESD Tester	KIKUSUI	KES4201A	UH002321	Apr. 2,2022	Apr. 1,2023

For RF Field Strength Susceptibility Test(SMQ)

For RF Field Strength Susceptibility Test (SMQ --- site)					
Equipment	Manufacturer	Model#	Serial#	Last Cal.	Next Cal.
Signal Generator	HP	8648A	3625U00573	Apr. 2,2022	Apr. 1,2023
Amplifier	A&R	500A100	17034	Apr. 2,2022	Apr. 1,2023
Amplifier	A&R	100W/1000M1	17028	Apr. 2,2022	Apr. 1,2023
Audio Analyzer (20Hz~1GHz)	Panasonic	2023B	202301/428	Apr. 2,2022	Apr. 1,2023
Isotropic Field Probe	A&R	FP2000	16755	Apr. 2,2022	Apr. 1,2023
Antenna	EMCO	3108	9507-2534	Apr. 2,2022	Apr. 1,2023
Log-periodic Antenna	A&R	AT1080	16812	Apr. 2,2022	Apr. 1,2023

For Electrical Fast Transient /Burst Immunity Test

For Electrical Fast Transient/Burst Immunity Test (A --- site)					
Equipment	Manufacturer	Model#	Serial#	Last Cal.	Next Cal.
Burst Tester	Prima	EFT61004AG	PR14054467	Apr. 2,2022	Apr. 1,2023
Coupling Clamp	Prima	EFT61004AG	DL009E	Apr. 2,2022	Apr. 1,2023

For Surge Test

For Surge Test (A --- site)					
Equipment	Manufacturer	Model#	Serial#	Last Cal.	Next Cal.
Burst Tester	Prima	EFT61004AG	PR14054467	Apr. 2,2022	Apr. 1,2023

For Injected Currents Susceptibility Test

For Injected Currents Susceptibility Test (A --- site)					
Equipment	Manufacturer	Model#	Serial#	Last Cal.	Next Cal.
C/S Test System	SCHLODER	CDG600	126B1281	Apr. 2,2022	Apr. 1,2023
CDN	SCHLODER	CDN-M2+3	A2210320/20 15	Apr. 2,2022	Apr. 1,2023
Injection Clamp	SCHLOBER	EMCL-20	132A1214/20 15	Apr. 2,2022	Apr. 1,2023

For Voltage Dips Interruptions Test

For Voltage Dips Interruptions Test (A --- site)					
Equipment	Manufacturer	Model#	Serial#	Last Cal.	Next Cal.
Dips Tester	Prima	DRP61011AG	PR14086284	Apr. 2,2022	Apr. 1,2023

3. CONDUCTED EMISSION AT THE MAINS TERMINALS TEST

3.1. Block Diagram Of Test Setup

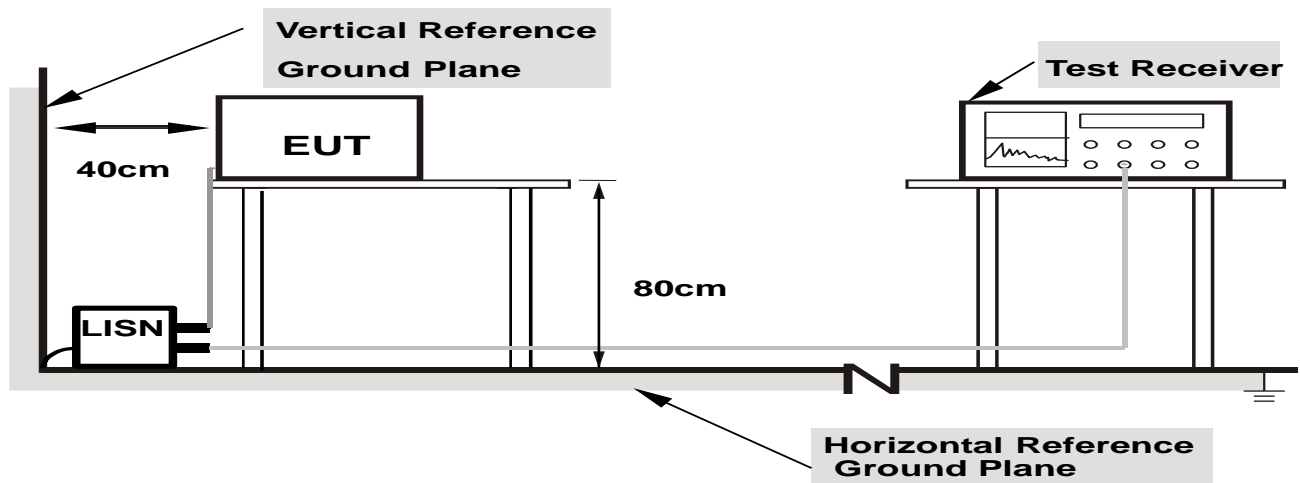

Note: 1. Support units were connected to second LISN.

2. Both of LISNs (AMN) are 80 cm from EUT and at least 80 from other units and other metal planes

3.2. Test Standard

EN 55014-1

3.3. Power Line Conducted Emission Limit

Frequency MHz	Limits dB(μ V)	
	Quasi-peak Level	Average Level
0.15 ~ 0.50	66 ~ 56*	59 ~ 46*
0.50 ~ 5.00	56	46
5.00 ~ 30.00	60	50

Notes: 1. *Decreasing linearly with logarithm of frequency.

2. The lower limit shall apply at the transition frequencies.

3.4. EUT Configuration on Test

The following equipments are installed on conducted emission test to meet EN 55014-1 requirement and operating in a manner which tends to maximize its emission characteristics in a normal application.

3.5. Operating Condition of EUT

3.5.1 Setup the EUT and simulators as shown in Section 3.1.

3.5.2 Turn on the power of all equipments.

3.5.3 Let the EUT work in test modes and test it.

3.6. Test Procedure

The EUT is put on the ground and connected to the AC mains through a Artificial Mains Network (AMN). This provided a 50ohm coupling impedance for the tested equipments. Both sides of AC line are checked to find out the maximum conducted emission levels according to the **EN 55014-1** regulations during conducted emission test.

The bandwidth of the test receiver (R&S Test Receiver ESCI) is set at 10KHz.

The frequency range from 150 KHz to 30 MHz is investigated.

3.7. Test Result

PASS

Please refer to the following page.

Conducted Emission Test Data			
Temperature:	24.9 °C	Relative Humidity:	56%
Pressure:	1009hPa	Phase :	Line
Test Voltage :	AC 230V/50Hz	Test Mode:	ON Mode

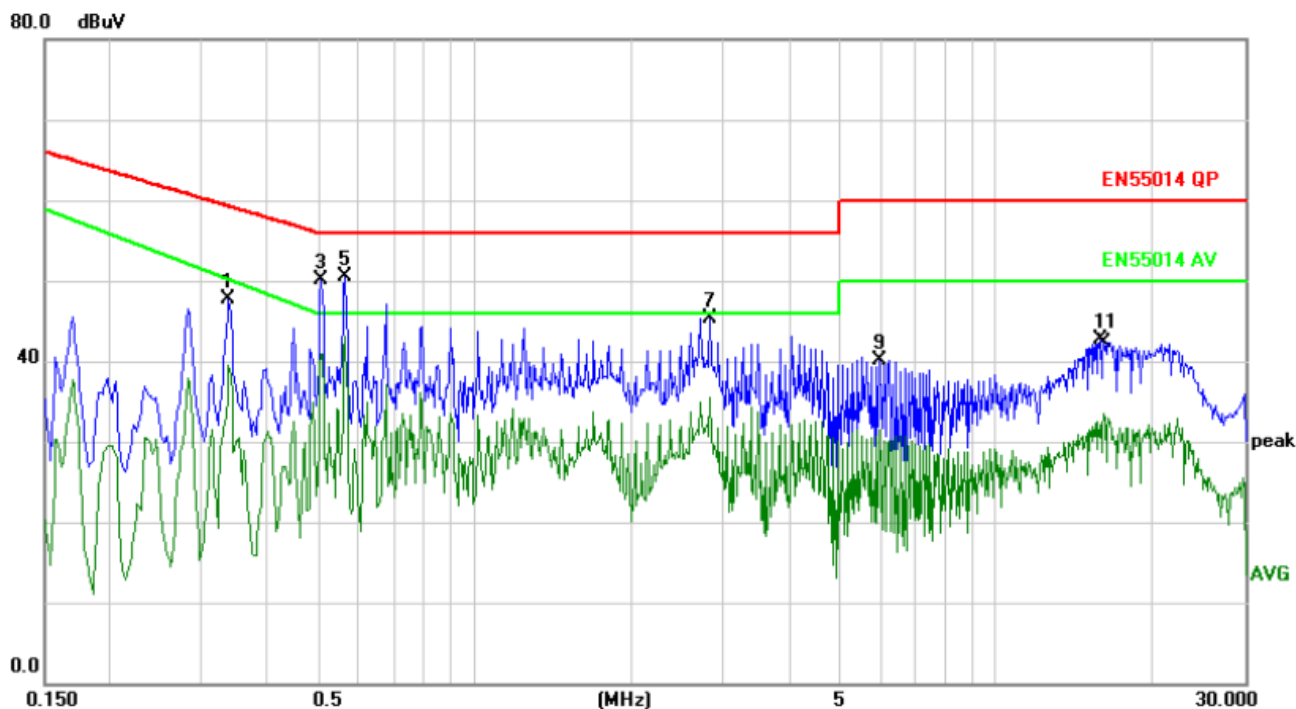

No.	Mk.	Freq. MHz	Reading Level dBuV	Correct Factor dB	Measure- ment dBuV	Limit dBuV	Over dB	Detector	Comment
1		0.3379	37.60	10.10	47.70	59.25	-11.55	peak	
2		0.3379	29.40	10.10	39.50	50.23	-10.73	AVG	
3		0.5100	39.93	10.12	50.05	56.00	-5.95	peak	
4		0.5100	30.83	10.12	40.95	46.00	-5.05	AVG	
5		0.5660	40.40	10.12	50.52	56.00	-5.48	peak	
6	*	0.5660	32.97	10.12	43.09	46.00	-2.91	AVG	
7		2.8260	35.08	10.19	45.27	56.00	-10.73	peak	
8		2.8260	25.32	10.19	35.51	46.00	-10.49	AVG	
9		5.9899	30.07	10.09	40.16	60.00	-19.84	peak	
10		5.9899	21.40	10.09	31.49	50.00	-18.51	AVG	
11		15.8660	32.49	10.15	42.64	60.00	-17.36	peak	
12		16.1020	23.38	10.15	33.53	50.00	-16.47	AVG	

Conducted Emission Test Data			
Temperature:	24.9 °C	Relative Humidity:	56%
Pressure:	1009hPa	Phase :	Neutral
Test Voltage :	AC 230V/50Hz	Test Mode:	ON Mode



No.	Mk.	Freq. MHz	Reading Level dBuV	Correct Factor dB	Measure- ment dBuV	Limit dBuV	Over dB	Detector	Comment
1		0.3379	36.45	10.10	46.55	59.25	-12.70	peak	
2		0.3379	27.49	10.10	37.59	50.23	-12.64	AVG	
3		0.5660	34.85	10.12	44.97	56.00	-11.03	peak	
4	*	0.5660	29.30	10.12	39.42	46.00	-6.58	AVG	
5		0.9020	20.74	10.16	30.90	46.00	-15.10	AVG	
6		1.0700	30.73	10.17	40.90	56.00	-15.10	peak	
7		2.5980	33.55	10.19	43.74	56.00	-12.26	peak	
8		2.8179	20.00	10.19	30.19	46.00	-15.81	AVG	
9		3.9500	19.97	10.16	30.13	46.00	-15.87	AVG	
10		4.1740	33.02	10.16	43.18	56.00	-12.82	peak	
11		15.5060	29.93	10.15	40.08	60.00	-19.92	peak	
12		16.8580	21.23	10.16	31.39	50.00	-18.61	AVG	

4. RADIATION EMISSION TEST

4.1. Block Diagram of Test Setup

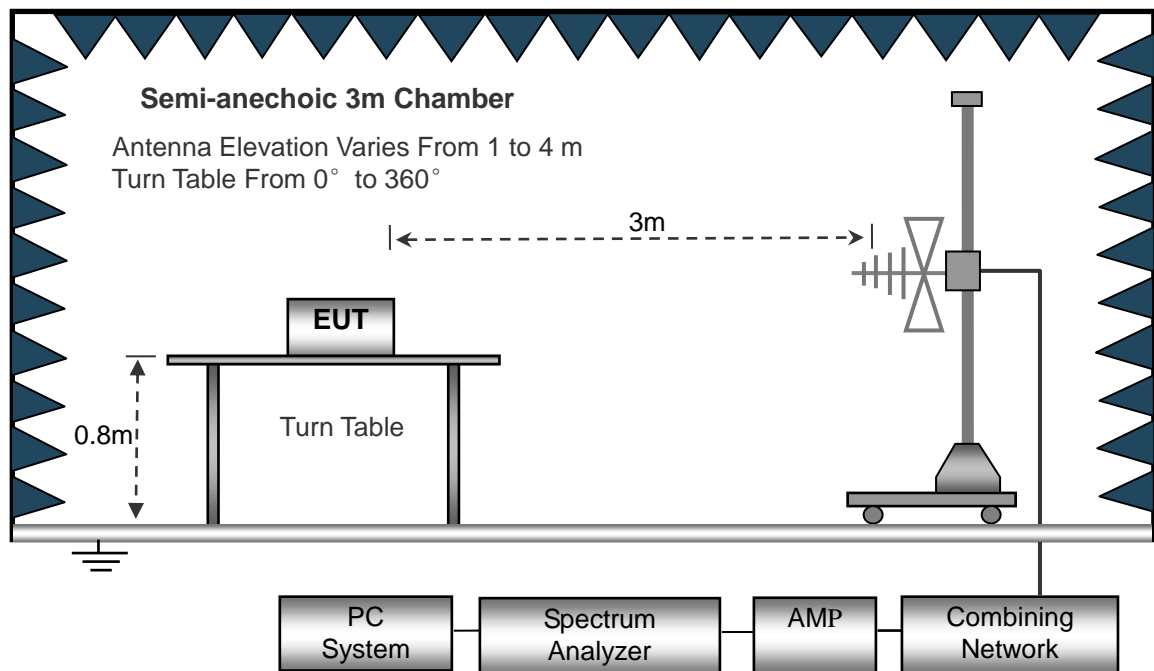

4.2. Test Standard

EN 55014-1

4.3. Radiation Limit

Frequency MHz	Distance (Meters)	Field Strengths Limits dB(μ V)/m
30 ~ 230	3	40.0
230 ~ 1000	3	47.0

Remark:

- (1) Emission level (dB(μ V)/m) = 20 log Emission level (μ V/m)
- (2) The smaller limit shall apply at the cross point between two frequency bands.
- (3) Distance refers to the distance in meters between the measuring instrument, antenna and the closed point of any part of the device or system.

4.4. EUT Configuration on Test

The EN 55014-1 regulations test method must be used to find the maximum emission during radiated emission test.

The configuration of EUT is the same as used in conducted emission test.

Please refer to Section 2.2.

4.5. Operating Condition of EUT

Same as conducted emission test, which is listed in Section 2.2 except the test set up replaced as Section 4.1.

4.6. Test Procedure

The EUT and its simulators are placed on a turned table that is 0.8 meter above the ground. The turned table can rotate 360 degrees to determine the position of the maximum emission level. The EUT is set 3 meters away from the receiving antenna that is mounted on the antenna tower. The antenna can move up and down between 1 meter and 4 meters to find out the maximum emission level. Broadband antenna (calibrated biconical and log periodical antenna) is used as receiving antenna. Both horizontal and vertical polarization of the antenna is set on test. In order to find the maximum emission levels, the interface cable must be manipulated according to EN 55014-1 on radiated emission test.

The bandwidth setting on the field strength meter (R&S Test Receiver ESCI) is set at 120KHz.

The frequency range from 30MHz to 1000MHz is checked.

4.7. Test Result

PASS

Please refer to the following page.

Radiation Emission Test Data			
Temperature:	24.9 °C	Relative Humidity:	58%
Pressure:	1009hPa	Phase :	Horizontal
Test Voltage :	AC 230V/50Hz	Test Mode:	ON Mode

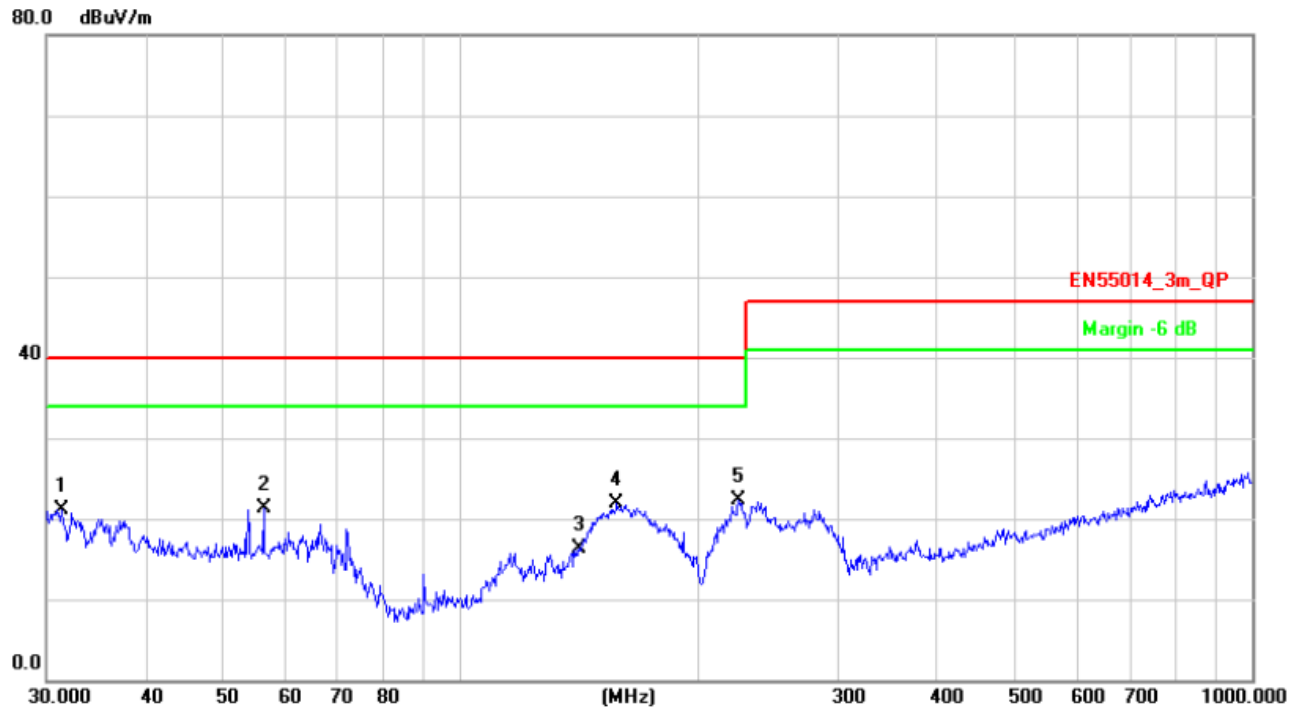

No. Mk.	Freq. MHz	Reading Level dBuV	Correct Factor dB/m	Measure- ment dBuV/m	Limit dBuV/m	Over dB	Detector	Antenna Height cm	Table Degree	Comment
1	31.2893	29.35	-8.20	21.15	40.00	-18.85	peak			
2	56.3948	32.59	-11.24	21.35	40.00	-18.65	peak			
3	141.3298	29.61	-13.32	16.29	40.00	-23.71	peak			
4	157.5588	34.68	-12.87	21.81	40.00	-18.19	peak			
5	* 224.5193	37.64	-15.37	22.27	40.00	-17.73	peak			

Radiation Emission Test Data			
Temperature:	24.9 °C	Relative Humidity:	58%
Pressure:	1009hPa	Phase :	Vertical
Test Voltage :	AC 230V/50Hz	Test Mode:	ON Mode

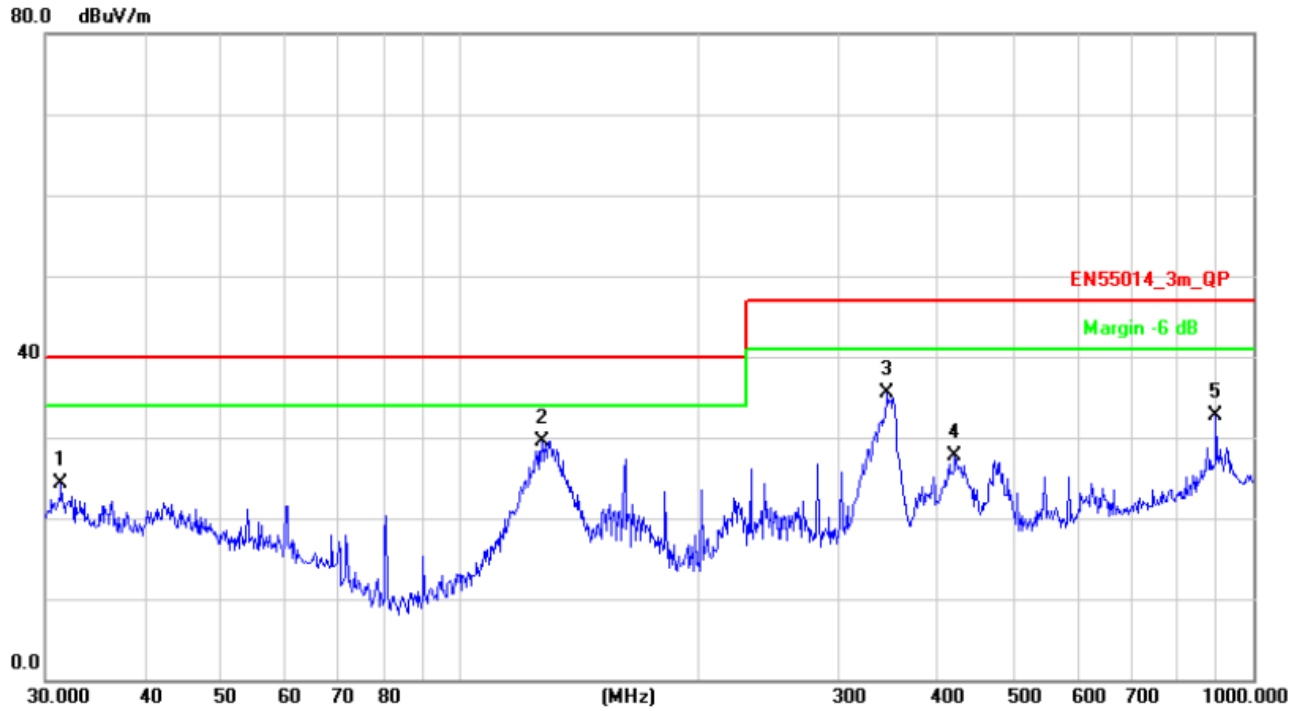

No.	Mk.	Freq.	Reading Level	Correct Factor	Measurement	Limit	Over	Antenna Height	Table Degree	Comment
		MHz	dBuV	dB/m	dBuV/m	dBuV/m	dB	cm	degree	
1		31.3992	32.46	-8.22	24.24	40.00	-15.76	peak		
2	*	126.7723	43.91	-14.31	29.60	40.00	-10.40	peak		
3		345.5952	46.98	-11.47	35.51	47.00	-11.49	peak		
4		420.5803	37.44	-9.73	27.71	47.00	-19.29	peak		
5		896.9965	34.22	-1.52	32.70	47.00	-14.30	peak		

5. HARMONIC CURRENT EMISSION TEST

5.1. Block Diagram of Test Setup

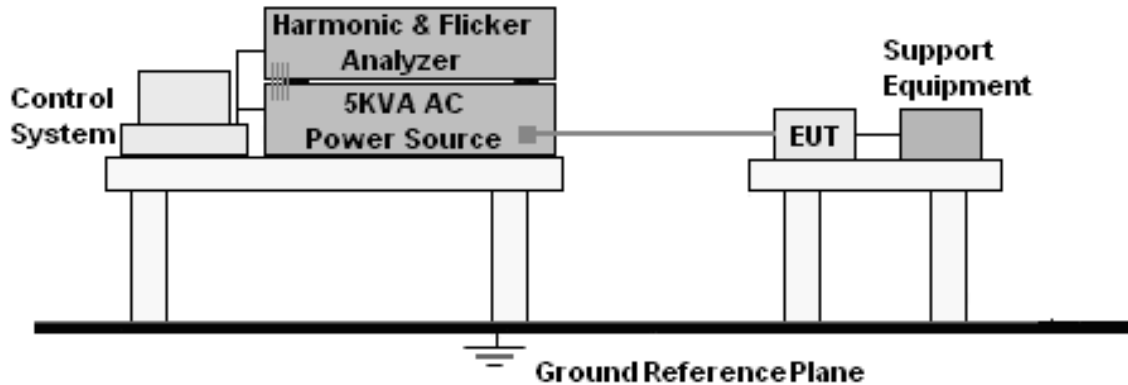

5.2. Test Standard

EN 61000-3-2

5.3. Operating Condition of EUT

Setup the EUT as shown in Section 5.1.
Turn on the power of all equipments.
Let the EUT work in test mode and test it.

5.4. Test Procedure

The power cord of the EUT is connected to the output of the test system. Turn on the power of the EUT and use the test system to test the harmonic current level.

5.5. Test Results

PASS

6. VOLTAGE FLUCTUATIONS & FLICKER TEST

6.1. Block Diagram of Test Setup

Same as Section 5.1.

6.2. Test Standard

EN 61000-3-3

6.3. Operating Condition of EUT

Same as Section 5.3.. The power cord of the EUT is connected to the output of the test system. Turn on the power of the EUT and use the test system to test the harmonic current level.

Flicker Test Limit

Test items	Limits
Pst	1.0
dc	3.3%
Tmax	4.0%
dt	Not exceed 3.3% for 500ms

6.4. Test Procedure

The power cord of the EUT is connected to the output of the test system. Turn on the power of the EUT and use the test system to test the harmonic current level.

6.5. Test Results

Flicker Test Data			
Temperature:	24.5 °C	Relative Humidity:	54%
Pressure:	1009hPa		
Test Voltage :	AC 230V/50Hz	Test Mode:	ON Mode

Voltage Fluctuation	Limit	Value
Relative Voltage Change Characteristic Tmax (dc > 3%)	500 ms	0 ms
Maximum Relative Voltage Change dmax	4%	0.00
	6%	/
	7%	/
Relative Steady-state Voltage Change dc	3.3%	0.00

Flicker	Limit	Value
Short-term Flicker Indicator Pst	1.0	0.063
Long-term Flicker Indicator Plt	0.65	/

7. IMMUNITY TEST OF GENERAL THE PERFORMANCE CRITERIA

Product Standard	EN 55014-2
CRITERION A	The apparatus shall continue to operate as intended during the test. No degradation of performance or loss of function is allowed below a performance level (or permissible loss of performance) specified by the manufacturer, when the apparatus is used as intended. If the minimum performance level or the permissible performance loss is not specified by the manufacturer, then either of these may be derived from the product description and documentation, and from what the user may reasonably expect from the apparatus if used as intended
CRITERION B	The apparatus shall continue to operate as intended after the test. No degradation of performance or loss of function is allowed below a performance level (or permissible loss of performance) specified by the manufacturer, when the apparatus is used as intended. During the test, degradation of performance is allowed, however, no change of actual operating state or stored data is allowed. If the minimum performance level or the permissible performance loss is not specified by the manufacturer, then either of these may be derived from the product description and documentation, and from what the user may reasonably expect from the apparatus if used as intended.
CRITERION C	Temporary loss of function is allowed, provided the function is self-recoverable or can be restored by the operation of the controls, or by any operation specified in the instructions for use.

8. ELECTROSTATIC DISCHARGE IMMUNITY TEST

8.1. Block Diagram of Test Setup

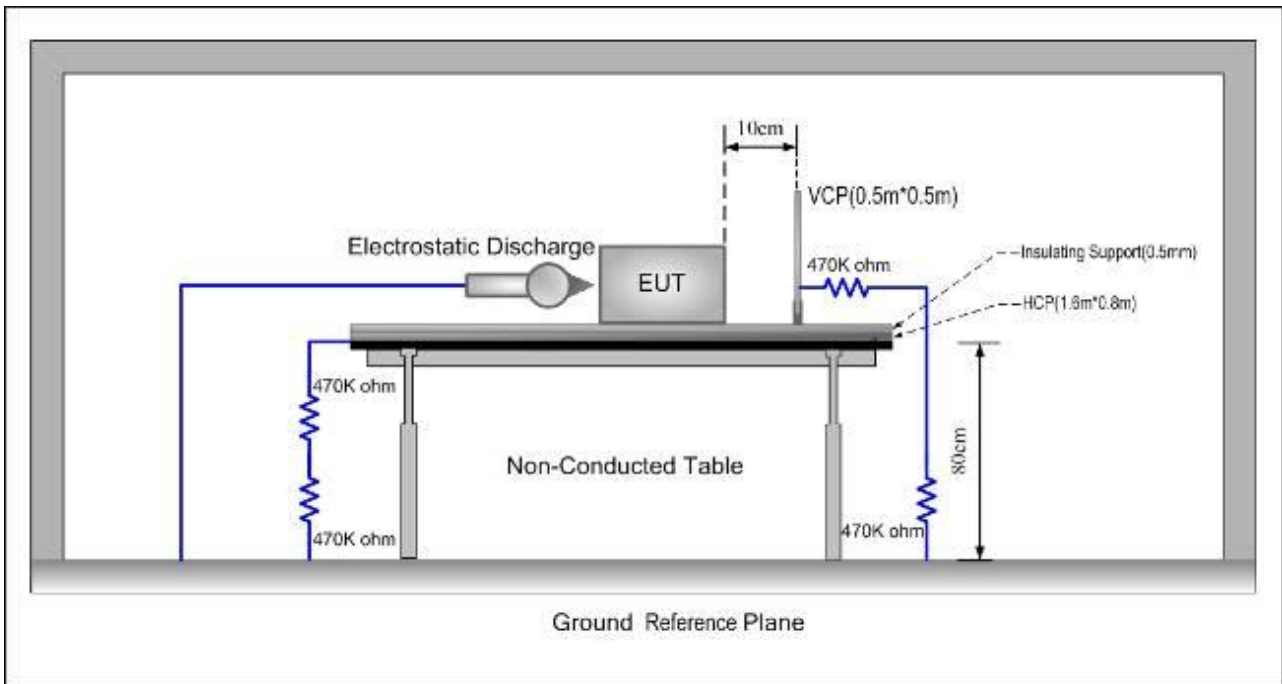

8.2. Test Standard

EN 55014-2, EN 61000-4-2
 Severity Level: 3 / Air Discharge: ±8KV
 Level: 2 / Contact Discharge: ±4KV

8.3. Severity Levels and Performance Criterion

Severity level

Level	Test Voltage Contact Discharge (KV)	Test Voltage Air Discharge (KV)
1.	±2	±2
2.	±4	±4
3.	±6	±8
4.	±8	±15
X	Special	Special

Performance criterion : B

8.4. Test Procedure

- a. Electrostatic discharges were applied only to those points and surfaces of the Product that are accessible to users during normal operation.
- b. The test was performed with at least ten single discharges on the pre-selected points in the most sensitive polarity.
- c. The time interval between two successive single discharges was at least 1 second.
- d. The ESD generator was held perpendicularly to the surface to which the discharge was applied and the return cable was at least 0.2 meters from the Product.
- e. Contact discharges were applied to the non-insulating coating, with the pointed tip of the generator penetrating the coating and contacting the conducting substrate.
- f. Air discharges were applied with the round discharge tip of the discharge electrode approaching the Product as fast as possible (without causing mechanical damage) to touch the Product. After each discharge, the ESD generator was removed from the Product and re-triggered for a new single discharge. The test was repeated until all discharges were complete.
- g. At least ten single discharges (in the most sensitive polarity) were applied to the Horizontal Coupling Plane at points on each side of the Product. The ESD generator was positioned vertically at a distance of 0.1 meters from the Product with the discharge electrode touching the HCP.
- h. At least ten single discharges (in the most sensitive polarity) were applied to the center of one vertical edge of the Vertical Coupling Plane in sufficiently different positions that the four faces of the Product were completely illuminated. The VCP (dimensions 0.5m x 0.5m) was placed vertically to and 0.1 meters from the Product.

8.5. Test Results

PASS

Please refer to the following data.

Electrostatic Discharge Test Data					
Temperature:	25.1°C	Humidity:	55%		
Power Supply :	AC 230V/50Hz	Test Mode:	ON Mode		
Discharge Method	Discharge Position	Voltage (±kV)	Min. No. of Discharge per polarity (Each Point)	Required Level	Result
Contact Discharge	Conductive Surfaces	4	10	B	Pass
	Indirect Discharge HCP	4	10	B	Pass
	Indirect Discharge VCP	4	10	B	Pass
Air Discharge	Slots, Apertures, and Insulating Surfaces	8	10	B	Pass
Note: N/A					

9. RF FIELD STRENGTH SUSCEPTIBILITY TEST

9.1. Block Diagram of Test Setup

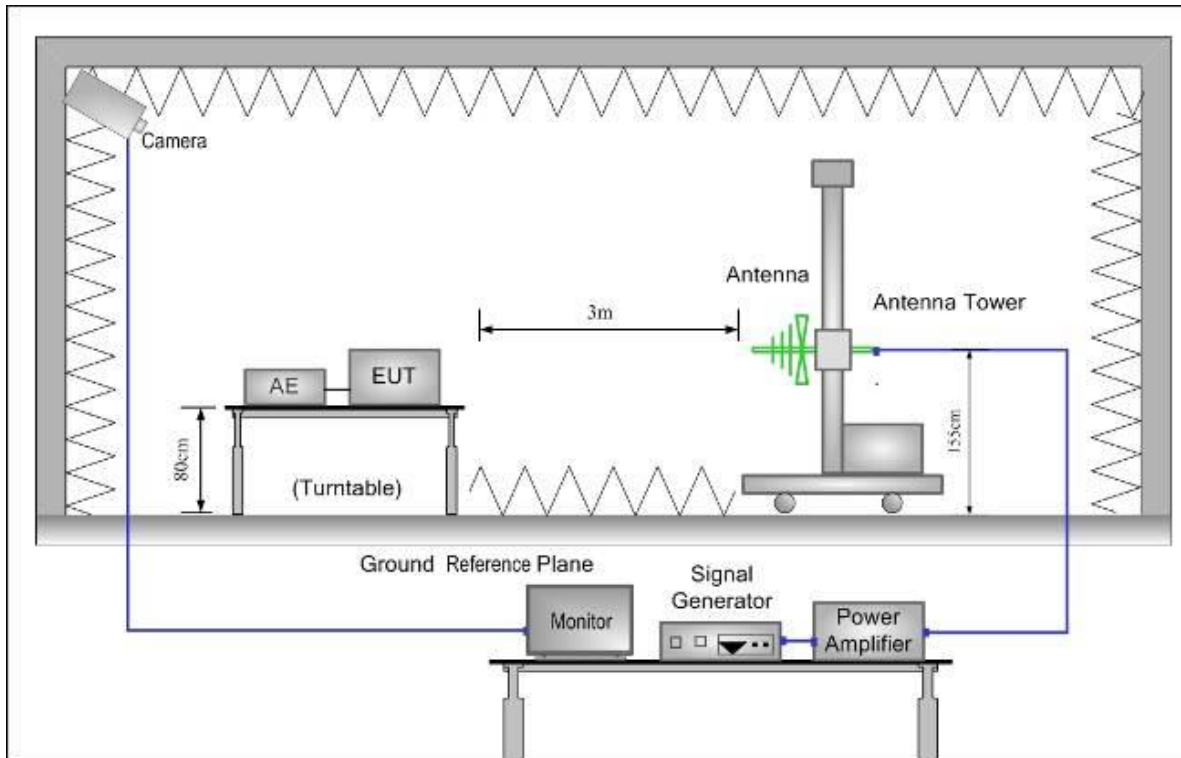

9.2. Test Standard

EN 55014-2, EN 61000-4-3
Severity Level 2, 3V / m

9.3. Severity Levels and Performance Criterion

Severity level

Level	Field Strength V/m
1.	1
2.	3
3.	10
X.	Special

Performance criterion: A

9.4. Test Procedure

The EUT and its simulators are placed on a turn table which is 0.8 meter above ground. EUT is set 3 meter away from the transmitting antenna which is mounted on an antenna tower. Both horizontal and vertical polarization of the antenna are set on test. Each of the four sides of EUT must be faced this transmitting antenna and measured individually.

All the scanning conditions are as follows :

Condition of Test	Remarks
1. Fielded Strength	3 V/m (Severity Level 2)
2. Radiated Signal	Modulated
3. Scanning Frequency	80 – 1000 MHz
4. Dwell time of radiated	0.0015 decade/s
5. Waiting Time	1 Sec.

9.5. Test Results

PASS

Please refer to the following data.

R/S Test Data				
Temperature:	25.1°C	Humidity:	55%	
Power Supply :	AC 230V/50Hz	Test Mode:	ON Mode	
Criterion:	A	Steps	1 %	
Frequency (MHz)	Position	Field Strength (V/m)	Required Level	Result
80 - 1000	Front, Right, Back, Left	3	A	Pass
Note: N/A				

10. ELECTRICAL FAST TRANSIENT/BURST IMMUNITY TEST

10.1. Block Diagram of EUT Test Setup

For input a.c. / d.c. power port:

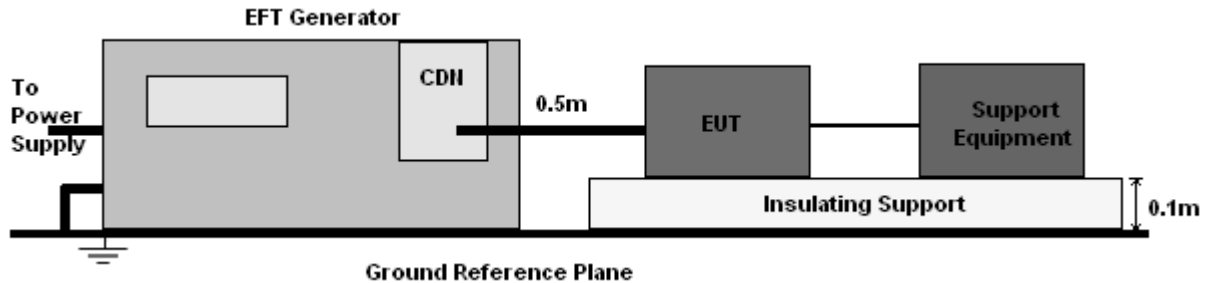

For signal lines and control lines:

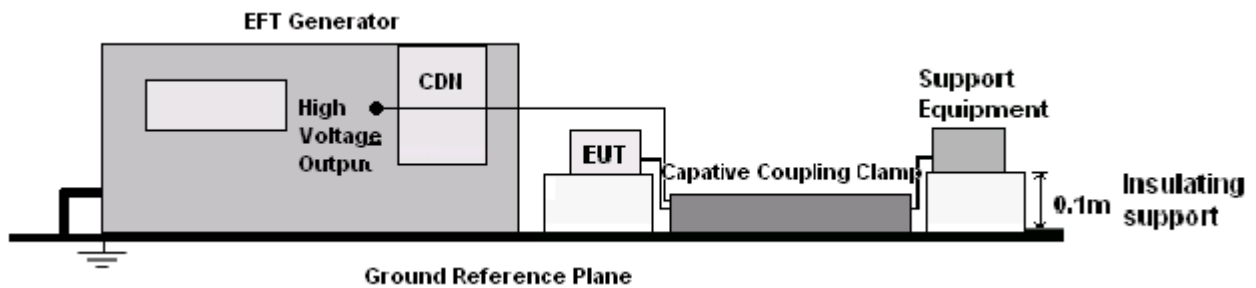

10.2. Test Standard

EN 55014-2, EN 61000-4-4

10.3. Severity Levels and Performance Criterion

Severity Level 2 at 1KV, Pulse Rise time & Duration: 5 nS / 50 nS

Severity Level:

Open Circuit Output Test Voltage $\pm 10\%$		
Level	On power ports	On I/O(Input/Output) Signal data and control ports
1.	0.5KV	0.25KV
2.	1KV	0.5KV
3.	2KV	1KV
4.	4KV	2KV
X.	Special	Special

Performance criterion: B

10.4. Test Procedure

EUT shall be placed 0.8m high above the ground reference plane which is a min.1m*1m metallic sheet with 0.65mm minimum thickness. This reference ground plane shall project beyond the EUT by at least 0.1m on all sides and the minimum distance between EUT and all other conductive structure, except the ground plane beneath the EUT, shall be more than 0.5m

For input and output AC power ports:

The EUT is connected to the power mains by using a coupling device which couples the EFT interference signal to AC power lines. Both polarities of the test voltage should be applied during compliance test and the duration of the test is 2 minutes.

10.5. Test Results

PASS

Please refer to the following data.

EFT Test Data			
Temperature:	24.5℃	Humidity:	53%
Power Supply :	AC 230V/50Hz	Test Mode:	ON Mode
Coupling Line	Test Voltage(kV)	Performance Criterion	Result
L	±0.5, 1	B	PASS
N	±0.5, 1	B	PASS
L-N	±0.5, 1	B	PASS

11. SURGE TEST

11.1. Block Diagram of EUT Test Setup

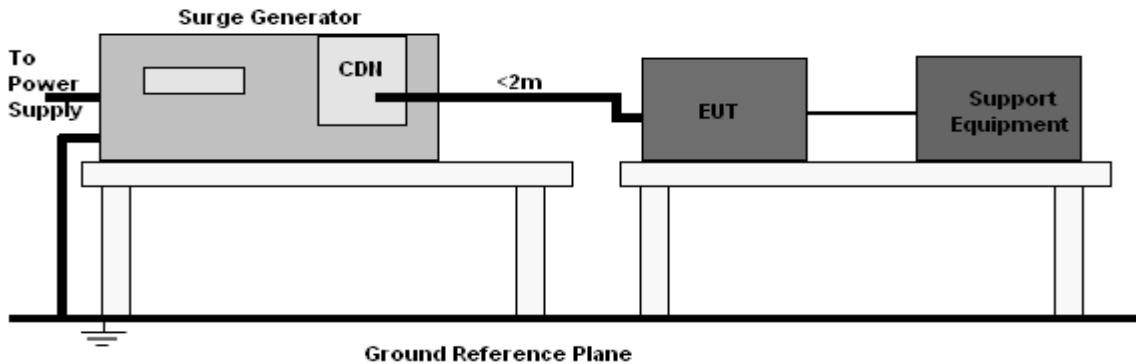

11.2. Test Standard

EN 55014-2, EN61000-4-5

11.3. Severity Levels and Performance Criterion

Severity Level: Line to Line, Level 2 at 1KV;
Severity Level: Line to Earth, Level 3 at 2KV.

Severity Level	Open-Circuit Test Voltage (KV)
1.	0.5
2.	1.0
3.	2.0
4.	4.0
X.	Special

Performance criterion: B

11.4. Test Procedure

- 1) Set up the EUT and test generator as shown on section 10.1
- 2) For line to line coupling mode, provide a 1KV 1.2/50us voltage surge (at open-circuit condition) and 8/20us current surge to EUT selected points.
- 3) At least 5 positive and 5 negative (polarity) tests with a maximum 1/min repetition rate are conducted during test.
- 4) Different phase angles are done individually.
- 5) Repeat procedure 2) to 4) except the open-circuit test voltage change from 1KV to 2KV for line to earth coupling mode test.
- 6) Record the EUT operating situation during compliance test and decide the EUT immunity criterion for above each test.

11.5. Test Result

PASS

Please refer to the following data.

Surge Test Data						
Temperature:	24.5°C		Humidity:	53%		
Power Supply :	AC 230V/50Hz		Test Mode:	ON Mode		
Location	Polarity	Phase Angle	No of Pulse	Pulse Voltage (KV)	Performance Criterion	Result
L-N	+	90	5	1	B	Pass
L-N	-	270	5	1	B	Pass
Note: N/A						

12. INJECTED CURRENTS SUSCEPTIBILITY TEST

12.1. Block Diagram of EUT Test Setup

For input a.c. / d.c. power port:

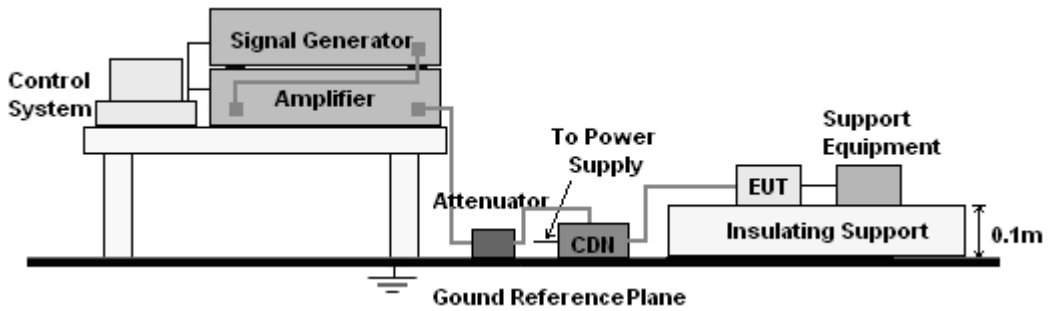

For signal lines and control lines:

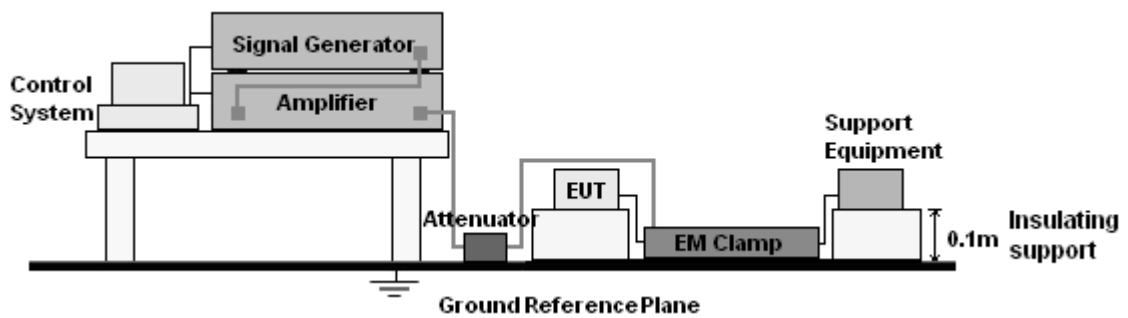

12.2. Test Standard

EN 55014-2, EN61000-4-6

12.3. Severity Levels and Performance Criterion

Severity Level 2: 3V(rms), 150KHz ~ 80MHz

Severity Level:

Level	Field Strength V
1.	1
2.	3
3.	10
X.	Special

Performance criterion: A

12.4. Test Procedure

- 1) Set up the EUT, CDN and test generator as shown on section 12.1
- 2) Let EUT work in test mode and measure.
- 3) The EUT and supporting equipments are placed on an insulating support 0.1m high above a ground reference plane. CDN (coupling and decoupling device) is placed on the ground plane at above 0.1-0.3m from EUT. Cables between CDN and EUT are as short as possible, and their height above the ground reference plane shall be between 30 and 50 mm (where possible).
- 4) The disturbance signal described below is injected to EUT through CDN.
- 5) The EUT operates within its operational mode(s) under intended climatic conditions after power on.
- 6) The frequency range is swept from 150KHz to 80MHz using 3V signal level, and with the disturbance signal 80% amplitude modulated with a 1KHz sine wave
- 7) The rate of sweep shall not exceed 1.5×10^{-3} decades/s. Where the frequency is swept incrementally, the step size shall not exceed 1% of the start and thereafter 1% of the preceding frequency value.
- 8) Recording the EUT operating situation during compliance test and decide the EUT immunity criterion for above each test.

12.5. Test Result

PASS

Please refer to the following data.

CS Test Data						
Temperature:	24.5°C		Humidity:	53%		
Power Supply :	AC 230V/50Hz		Test Mode:	ON Mode		
Frequency Range(MHz)	Injected Position	Strength	Modulation Signal	Freq. Step	Performance Criterion	Result
150KHz ~ 80MHz	AC Line	3V(rms), Unmodulated	AM 80%, 1kHz sine wave	1%	A	Pass
150KHz ~ 80MHz	DC Line, Signal Line	3V(rms), Unmodulated	AM 80%, 1kHz sine wave	1%	/	/
Note: N/A						

13. VOLTAGE DIPS AND INTERRUPTIONS TEST

13.1. Block Diagram of EUT Test Setup

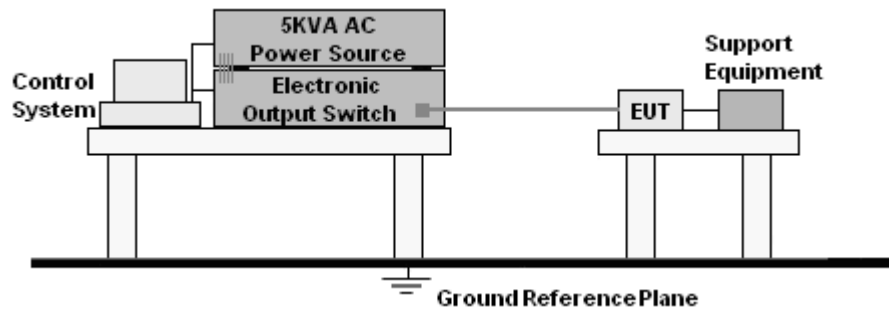

13.2. Test Standard

EN 55014-2, EN61000-4-11

13.3. Severity Levels and Performance Criterion

Severity Level:

Input and Output AC Power Ports.

- Voltage Dips.
- Voltage Interruptions.

Environmental Phenomena	Test Specification	Units	Performance Criterion
Voltage Dips	70	% Reduction period	C
	25		
	40	% Reduction period	C
10			
Voltage Interruptions	0	% Reduction period	C
	0.5		

13.4. Test Procedure

Set up the EUT and test generator as shown on section 13.1

The interruption is introduced at selected phase angles with specified duration.

There is a 3mins minimum interval between each test event.

After each test a full functional check is performed before the next test.

Repeat procedures 2 & 3 for voltage dips, only the level and duration is changed.

Record any degradation of performance.

13.5. Test Result

PASS

Please refer to the following data.

DIPS Test Data			
Temperature:	24.5°C	Humidity:	53%
Power Supply :	AC 230V/50Hz	Test Mode:	ON Mode
Environmental Phenomena	Test Specification	Units	Performance Criterion
Voltage Dips	70	% Reduction period	C
	25		
Voltage Interruptions	40	% Reduction period	C
	10		
	0	% Reduction period	C
	0.5		

14. EUT PHOTOGRAPHS



Photo1



Photo2

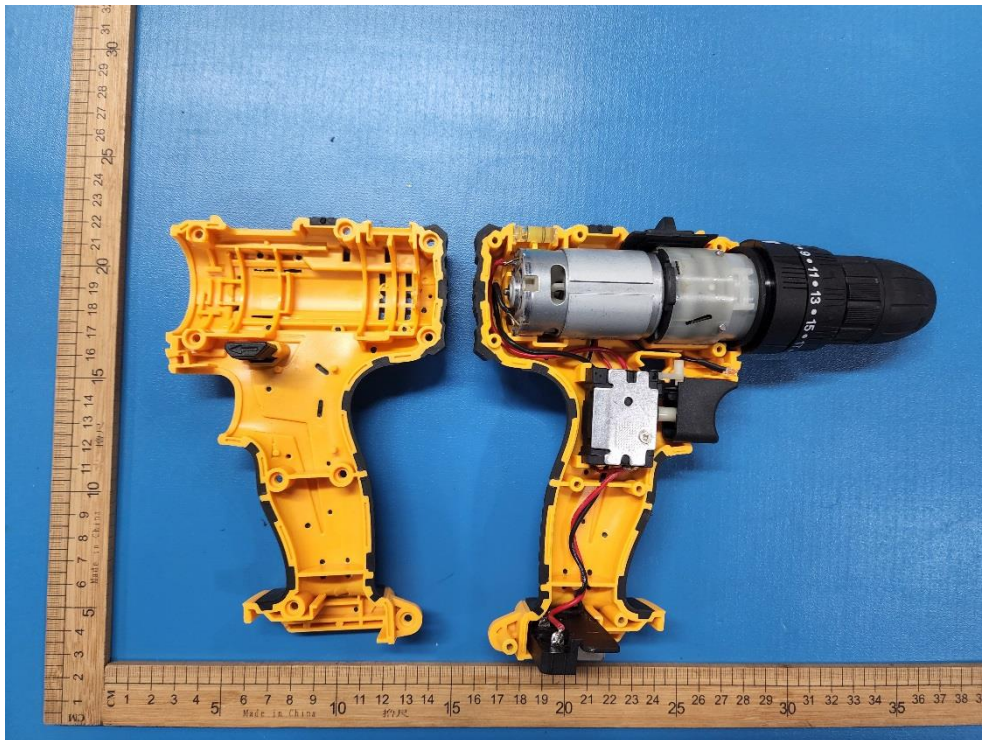

Photo3



Photo4

***** End of Report *****